

Varenummer: 0106065  
 Beskrivelse: Seeger låsering JV 48

## Mål

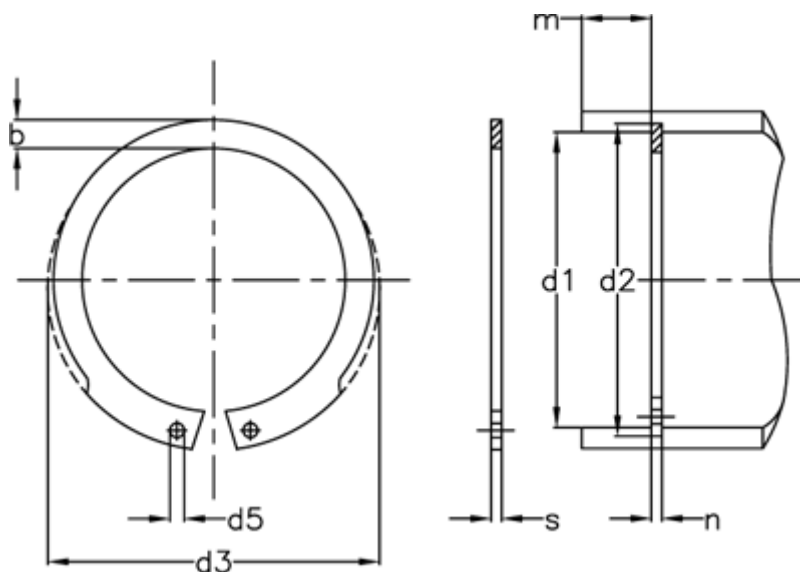

AN mm <sup>2</sup>	= 96	FRg kN	= 9.1	Tang	= ZGJ-2
b	= 4.7	FR kN	= 48.0	tol	= -0.06
Betegnelse	= JV 48	g	= 2.0	tol	= +1,10-0,46
d1	= 48	K kN-mm	= 85.8	tol	= +0,30
d2	= 50.5	m min	= 1.85	tol	= 0.2
d3	= 51.5	Nominel træk	= 4.5	vægt kg/1000	= 7.00
d5 min	= 2.0	s	= 1.75		
FN kN	= 16.00	t	= 1.25		